



Zip HydroTap All-in-One Celsius Arc

FILTERED: BOILING CHILLED SPARKLING
UNFILTERED: HOT & COLD

The ultimate in functionality, the All-in-One Arc offers all five water types - filtered boiling, chilled and sparkling water, plus unfiltered hot and cold water - from a single tap. And it's all wrapped up in Zip's enduringly elegant Arc design. Perfect for the workplace kitchen, users will benefit from everything you'd expect from the HydroTap, including advanced filtration and energy saving features.



STANDARD

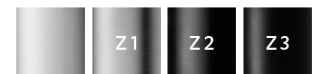

PLATINUM



MODEL	MIXED HOT AND COLD	FILTRATION 0.2 MICRON	FONT	CO ₂	NOMINAL POWER RATING KW	COMMAND CENTRE DIMENSIONS W X D X H
MT2769Z5UK	Y	Y	N	Y	2.3 kW @ 230V	450mm x 470mm x 335mm

For details of the alternative tap finishes and accessories please see the 'Accessories' section

Features and benefits

Advanced filtration

Integral 0.2 micron NSF certified Zip MicroPurity filtration system offers 25 times better filtration than a standard water filter jug, eliminating bad taste and odour of chlorine, heavy metals and impurities as tiny as one five-thousandth of a millimetre, but leaving beneficial fluoride.

Power-Pulse™ technology

Reduces energy consumption by allowing the system to regulate its power during periods of high and low usage.

Unique safety features

The Zip HydroTap is designed with safety front of mind, with boiling isolation, cool touch tap and safety lock features.

Touchscreen diagnostics

The compact under-counter unit includes a simple PIN code protected touchscreen that puts the user in total control of the system, including temperature, dispensing time, safety features, energy-saving settings and continuous auto-diagnostics.



Product detail

Specification type

Product code	MT2769Z5UK
Product name	HydroTap G4 All-in-One Arc boiling chilled sparkling 240/175 plus hot & cold mains brushed rose gold for work

Capacity, weights & dimensions

Water functions	Boiling, Chilled, Sparkling
Boosted boiling capacity	240 Cups per hour
Chilled capacity	175 Glasses per hour
Sparkling capacity	175 Glasses per hour
Unit dimension (W x D x H)	450mm x 470mm x 335mm
Product weight - empty / full	39kg / 47kg

Plumbing

Wholesome water inlet supply required	Hot & Cold Feed
Supply pressure range	2.5bar - 5bar
Supply connection (hot & cold)	1 x isolated 1/2" bsp BSP fitting (flexible supply hoses included)
Installation	Must comply with current water supply regulations

Electrical

Command centre power rating	2.3 kW @ 230V
Booster power rating	2.2 kW @ 230V
Voltage supply	13 amps
Power supply requirements	2 x 13amp socket outlet
Cable length	1.8m fitted with UK standard 3-pin plug
Installation	Must comply with current IEE regulations

Tap design

Style	HydroTap All-in-One Celsius Arc
Finish	Brushed Rose Gold
Installation hole cut size	50mm
Rotation	180 degree
Disability options	No
Country of Origin	Australia

Command centre

Factory temperature boiling	98°C
Factory temperature chilled	3-5°C
Filtration	0.2 Micron Filter Cartridge
Flow rate	3.0-4.0 l/min
Wholesome water supply requirements	Hot & Cold Feed
Refrigerant	R134a
Tank material	Stainless Steel
Country of origin	Australia

Tap installation

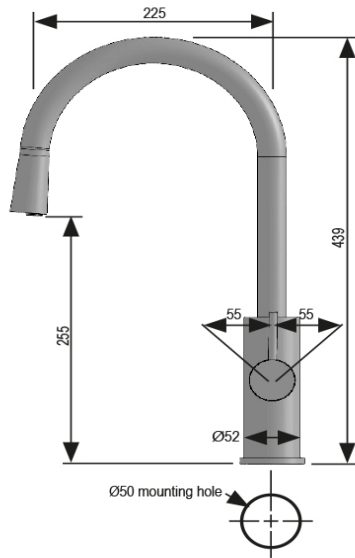



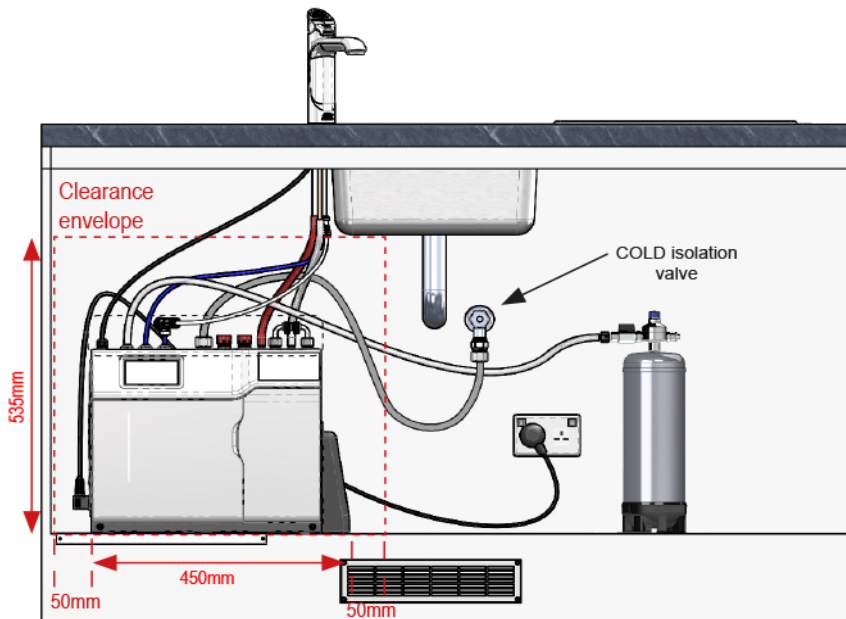

Under-counter unit installation

Clearance space required
for under counter unit



Accessories

Visit specify.zipwater.co.uk to find out more information about Zip HydroTap All-in-One Celsius Arc Accessories

Image	SKU	Title
	FL250G4KIT	Limescale prevention filter kit 2,250 litres
	FL500G4KIT	Limescale prevention filter kit 3,750 litres
	FL1000G4KIT	Limescale prevention filter kit 7,000 litres
	FL1500G4KIT	Limescale prevention filter kit 10,000 litres
	FL2000G4KIT	Limescale prevention filter kit 16,500 litres