



# Zip HydroTap Arc

**FILTERED: BOILING CHILLED**

Zip's design-led Arc HydroTap have been created with the architect and specifier in mind. As practical as it is beautiful, the HydroTap Design range marries functionality and style. Now available for the workplace as well as home, design-driven offices can now benefit from instant filtered boiling, chilled and sparkling water from a tap that doesn't disappoint in terms of style.



STANDARD

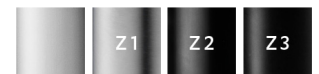

PLATINUM



| MODEL      | MIXED HOT AND COLD | FILTRATION 0.2 MICRON | FONT | CO <sub>2</sub> | NOMINAL POWER RATING KW | COMMAND CENTRE DIMENSIONS W X D X H |
|------------|--------------------|-----------------------|------|-----------------|-------------------------|-------------------------------------|
| HT2704Z3UK | N                  | Y                     | Y    | N               | 2.2 kW @ 230V           | 450mm x 470mm x 335mm               |

For details of the alternative tap finishes and accessories please see the 'Accessories' section

## Features and benefits

### Advanced filtration

Integral 0.2 micron NSF certified Zip MicroPurity filtration system offers 25 times better filtration than a standard water filter jug, eliminating bad taste and odour of chlorine, heavy metals and impurities as tiny as one five-thousandth of a millimetre, but leaving beneficial fluoride.

### Power-Pulse™ technology

Reduces energy consumption by allowing the system to regulate its power during periods of high and low usage.

### Unique safety features

The Zip HydroTap is designed with safety front of mind, with boiling isolation, cool touch tap and safety lock features.

### Touchscreen diagnostics

The compact under-counter unit includes a simple PIN code protected touchscreen that puts the user in total control of the system, including temperature, dispensing time, safety features, energy-saving settings and continuous auto-diagnostics.



## Product detail

---

### Specification type

---

|              |   |
|--------------|---|
| Product code | HT2704Z3UK  |
| Product name | HydroTap G4 Arc boiling chilled 160/175 matt black for work |

---

### Capacity, weights & dimensions

---

|                               |                       |
|-------------------------------|-----------------------|
| Water functions               | Boiling, Chilled      |
| Boiling capacity              | 160 Cups per hour     |
| Chilled capacity              | 175 Glasses per hour  |
| Unit dimension (W x D x H)    | 450mm x 470mm x 335mm |
| Product weight - empty / full | 28kg / 33kg           |

---

### Plumbing

---

|                                       |   |
|---------------------------------------|---|
| Wholesome water inlet supply required | Cold Feed   |
| Supply pressure range                 | 1.7bar - 5bar   |
| Supply connection (hot & cold)        | 1 x isolated 1/2"bsp BSP fitting (flexible supply hoses included) |
| Installation                          | Must comply with current water supply regulations                 |

---

### Electrical

---

|                             |  |
|-----------------------------|--|
| Command centre power rating | 2.2 kW @ 230V                            |
| Voltage supply              | 13 amps                                  |
| Power supply requirements   | 1 x 13amp socket outlet                  |
| Cable length                | 1.8m fitted with UK standard 3-pin plug  |
| Installation                | Must comply with current IEE regulations |

---

## Tap design

|                            |              |
|----------------------------|--------------|
| Style                      | HydroTap Arc |
| Finish                     | Matt Black   |
| Installation hole cut size | 35mm         |
| Rotation                   | Fixed        |
| Disability options         | No           |
| Country of Origin          | Australia    |

## Command centre

|                                     |                             |
|-------------------------------------|-----------------------------|
| Factory temperature boiling         | 98°C                        |
| Factory temperature chilled         | 3-5°C                       |
| Filtration                          | 0.2 Micron Filter Cartridge |
| Flow rate                           | 3.0-4.0 l/min               |
| Wholesome water supply requirements | Cold Feed                   |
| Refrigerant                         | R134a                       |
| Tank material                       | Stainless Steel             |
| Country of origin                   | Australia                   |

## Tap installation

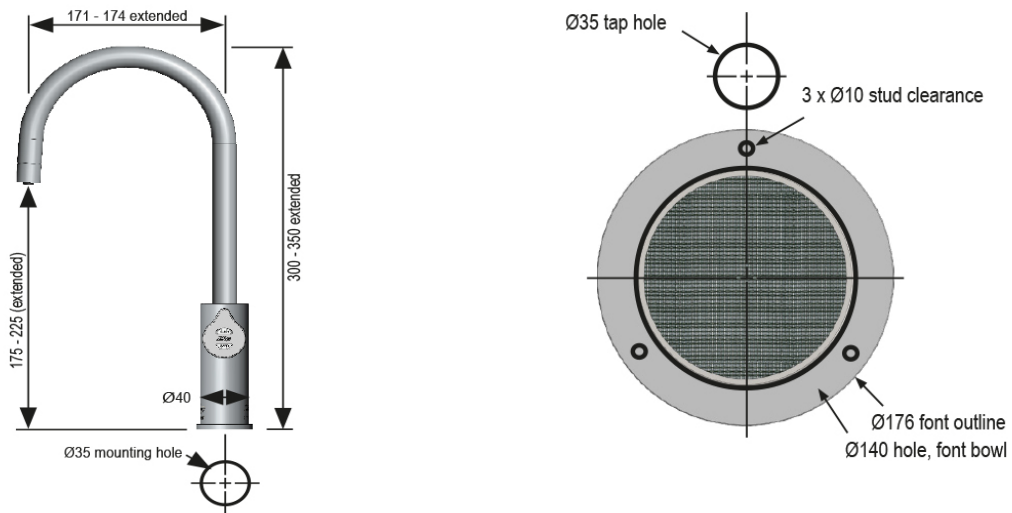

## Under-counter unit installation



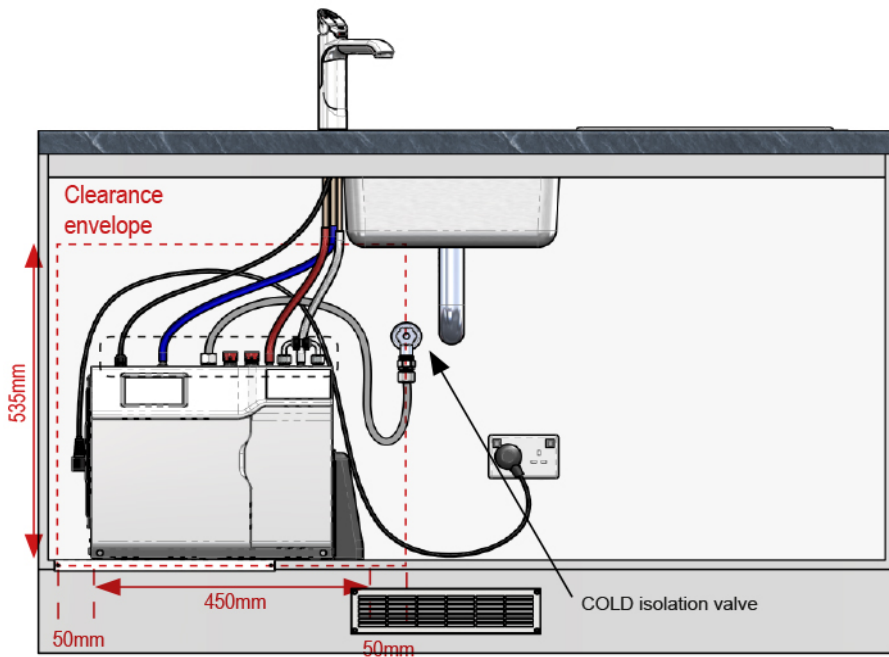





Clearance space required  
for under counter unit



## Accessories

---

Visit [specify.zipwater.co.uk](https://specify.zipwater.co.uk) to find out more information about Zip HydroTap Arc Accessories

| Image   | SKU         | Title   |
|---|-------------|---|
|    | ZT006       | Drainless font kit for HydroTap                       |
|    | 93441Z3UK   | Font for Arc & Cube matt black                        |
|    | FL170G4KIT  | Limescale prevention filter kit for home 1,700 litres |
|    | FL250G4KIT  | Limescale prevention filter kit 2,250 litres          |
|  | FL500G4KIT  | Limescale prevention filter kit 3,750 litres          |
|  | FL1000G4KIT | Limescale prevention filter kit 7,000 litres          |
|  | FL1500G4KIT | Limescale prevention filter kit 10,000 litres         |
|  | FL2000G4KIT | Limescale prevention filter kit 16,500 litres         |