



# Zip HydroTap Classic

**FILTERED: BOILING AMBIENT**

Offering the choice of instant filtered boiling, chilled or sparkling water in various combinations, or all three, the iconic industrial design of the Classic remains a much-loved and popular choice suited to any workplace or home. A safe, energy-efficient and highly functional appliance, we offer models to suit a range of business sizes and needs.



STANDARD



| MODEL      | MIXED HOT AND COLD | FILTRATION 0.2 MICRON | FONT | CO <sub>2</sub> | NOMINAL POWER RATING KW | COMMAND CENTRE DIMENSIONS W X D X H |
|------------|--------------------|-----------------------|------|-----------------|-------------------------|-------------------------------------|
| HT1763Z3UK | N                  | Y                     | Y    | N               | 1.9 kW @ 230V           | 280mm x 313mm x 335mm               |

For details of the alternative tap finishes and accessories please see the 'Accessories' section

## Features and benefits

### Advanced filtration

Integral 0.2 micron NSF certified Zip MicroPurity filtration system offers 25 times better filtration than a standard water filter jug, eliminating bad taste and odour of chlorine, heavy metals and impurities as tiny as one five-thousandth of a millimetre, but leaving beneficial fluoride.

### Power-Pulse™ technology

Reduces energy consumption by allowing the system to regulate its power during periods of high and low usage.

### Unique safety features

The Zip HydroTap is designed with safety front of mind, with boiling isolation, cool touch tap and safety lock features.

### Touchscreen diagnostics

The compact under-counter unit includes a simple PIN code protected touchscreen that puts the user in total control of the system, including temperature, dispensing time, safety features, energy-saving settings and continuous auto-diagnostics.



## Product detail

---

### Specification type

---

|              |   |
|--------------|---|
| Product code | HT1763Z3UK  |
| Product name | HydroTap G4 Classic boiling chilled sparkling 240/175 matt black for work |

---

### Capacity, weights & dimensions

---

|                               |                       |
|-------------------------------|-----------------------|
| Water functions               | Boiling, Ambient      |
| Boosted boiling capacity      | 240 Cups per hour     |
| Unit dimension (W x D x H)    | 280mm x 313mm x 335mm |
| Product weight - empty / full | 13kg / 14kg           |

---

### Plumbing

---

|                                       |   |
|---------------------------------------|---|
| Wholesome water inlet supply required | Cold Feed   |
| Supply pressure range                 | 1.7bar - 5bar   |
| Supply connection (hot & cold)        | 1 x isolated 1/2"bsp BSP fitting (flexible supply hoses included) |
| Installation                          | Must comply with current water supply regulations                 |

---

### Electrical

---

|                             |  |
|-----------------------------|--|
| Command centre power rating | 1.9 kW @ 230V                            |
| Booster power rating        | 2.2 kW @ 230V                            |
| Voltage supply              | 13 amps                                  |
| Power supply requirements   | 2 x 13amp socket outlet                  |
| Cable length                | 1.8m fitted with UK standard 3-pin plug  |
| Installation                | Must comply with current IEE regulations |

---

## Tap design

---

|                            |                  |
|----------------------------|------------------|
| Style                      | HydroTap Classic |
| Finish                     | Matt Black       |
| Installation hole cut size | 35mm             |
| Rotation                   | Fixed            |
| Disability options         | Yes              |
| Country of Origin          | Australia        |

---

## Command centre

---

|                                     |                             |
|-------------------------------------|-----------------------------|
| Factory temperature boiling         | 98°C                        |
| Filtration                          | 0.2 Micron Filter Cartridge |
| Flow rate                           | 4 l/min                     |
| Wholesome water supply requirements | Cold Feed                   |
| Tank material                       | Stainless Steel             |
| Country of origin                   | Australia                   |

---

## Tap installation

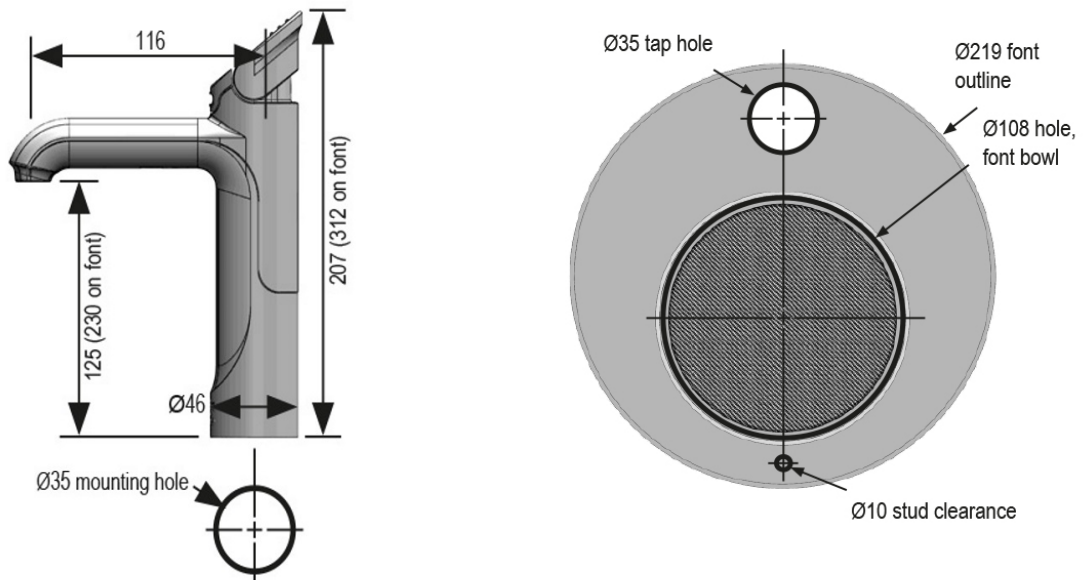

## Under-counter unit installation



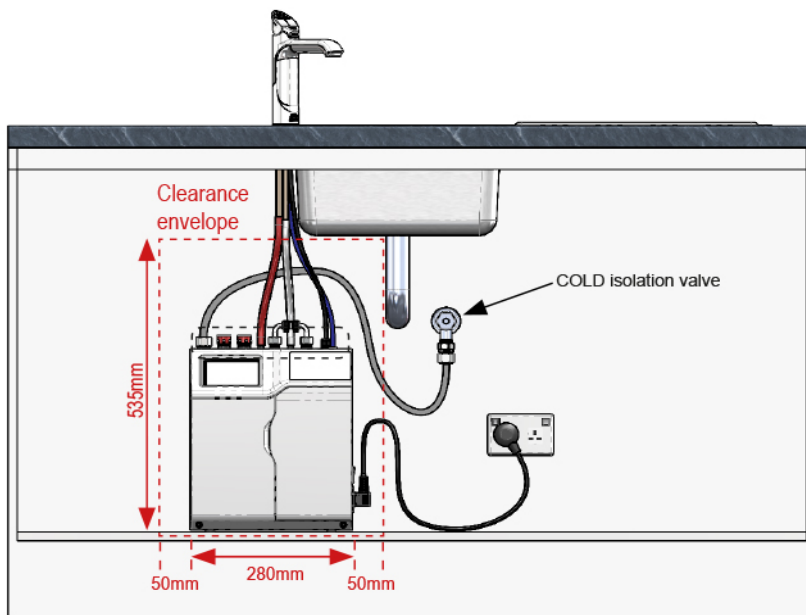





Clearance space required  
for under counter unit



## Accessories

---

Visit [specify.zipwater.co.uk](https://specify.zipwater.co.uk) to find out more information about Zip HydroTap Classic Accessories

| Image   | SKU         | Title  |
|---|-------------|--|
|    | SP99001     | 50mm to 35mm hole cut adaptor for HydroTap                     |
|    | ZT006       | Drainless font kit for HydroTap                                |
|    | ZT013       | Font adaptor Billi replacement                                 |
|   | 90915Z3UK   | Integrated tap font for HydroTap G4 Classic & Elite matt black |
|  | FL500G4KIT  | Limescale prevention filter kit 3,750 litres                   |
|  | FL1000G4KIT | Limescale prevention filter kit 7,000 litres                   |
|  | FL1500G4KIT | Limescale prevention filter kit 10,000 litres                  |
|  | FL2000G4KIT | Limescale prevention filter kit 16,500 litres                  |