



# Zip HydroTap Classic

**FILTERED: BOILING CHILLED SPARKLING**

Offering the choice of instant filtered boiling, chilled or sparkling water, or all three in any combination, the iconic industrial design of the Classic remains a much-loved and popular choice suited to any workplace or home. A safe, energy-efficient and highly functional appliance, we offer models to suit a range of business sizes and needs.



STANDARD

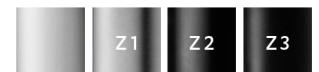

MODEL	MIXED HOT AND COLD	FILTRATION 0.2 MICRON	FONT	CO <sub>2</sub>	NOMINAL POWER RATING KW	COMMAND CENTRE DIMENSIONS W X D X H
HT1762Z1UK	N	Y	Y	Y	2.3 kW @ 230V	450mm x 470mm x 335mm

For details of the alternative tap finishes and accessories please see the 'Accessories' section

## Features and benefits

### Advanced filtration

Integral 0.2 micron NSF certified Zip MicroPurity filtration system offers 25 times better filtration than a standard water filter jug, eliminating bad taste and odour of chlorine, heavy metals and impurities as tiny as one five-thousandth of a millimetre, but leaving beneficial fluoride.

### Power-Pulse™ technology

Reduces energy consumption by allowing the system to regulate its power during periods of high and low usage.

### Unique safety features

The Zip HydroTap is designed with safety front of mind, with boiling isolation, cool touch tap and safety lock features.

### Touchscreen diagnostics

The compact under-counter unit includes a simple PIN code protected touchscreen that puts the user in total control of the system, including temperature, dispensing time, safety features, energy-saving settings and continuous auto-diagnostics.



## Product detail

---

### Specification type

---

Product code	HT1762ZIUK
Product name	HydroTap G4 Classic boiling chilled sparkling 160/175 brushed chrome for work

---

### Capacity, weights & dimensions

---

Water functions	Boiling, Chilled, Sparkling
Boiling capacity	160 Cups per hour
Chilled capacity	175 Glasses per hour
Sparkling capacity	175 Glasses per hour
Unit dimension (W x D x H)	450mm x 470mm x 335mm
Product weight - empty / full	39kg / 47kg

---

### Plumbing

---

Wholesome water inlet supply required	Cold Feed
Supply pressure range	2.5bar - 5bar
Supply connection (hot & cold)	1 x isolated 1/2" bsp BSP fitting (flexible supply hoses included)
Installation	Must comply with current water supply regulations

---

### Electrical

---

Command centre power rating	2.3 kW @ 230V
Voltage supply	13 amps
Power supply requirements	1 x 13amp socket outlet
Cable length	1.8m fitted with UK standard 3-pin plug
Installation	Must comply with current IEE regulations

---

## Tap design

Style	HydroTap Classic
Finish	Brushed Chrome
Installation hole cut size	35mm
Rotation	Fixed
Disability options	Yes
Country of Origin	Australia

## Command centre

Factory temperature boiling	98°C
Factory temperature chilled	3-5°C
Filtration	0.2 Micron Filter Cartridge
Flow rate	3.0-4.0 l/min
Wholesome water supply requirements	Cold Feed
Refrigerant	R134a
Tank material	Stainless Steel
Country of origin	Australia

## Tap installation

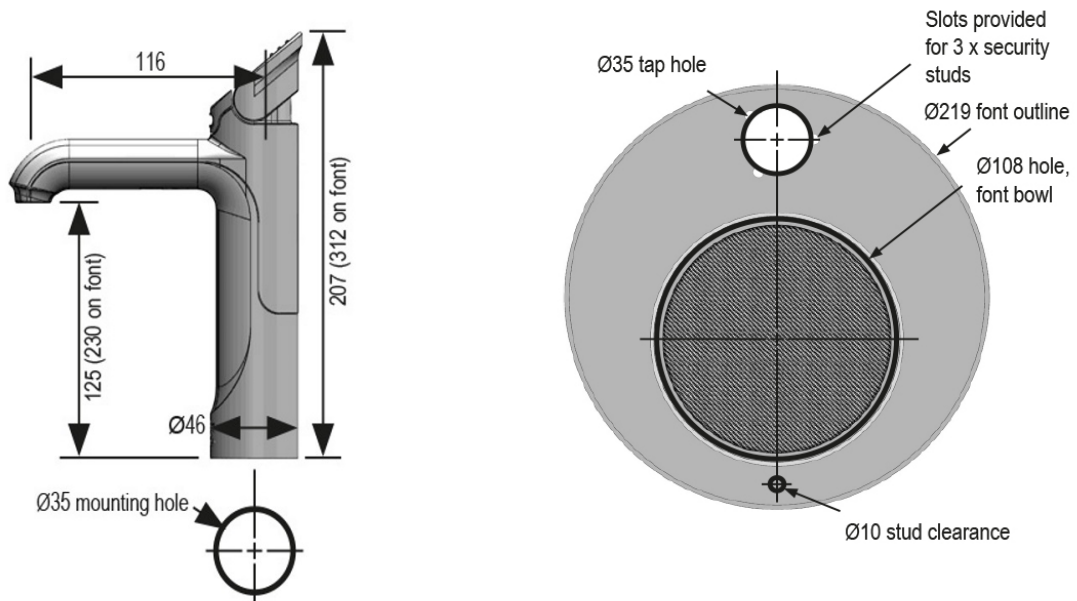

## Under-counter unit installation



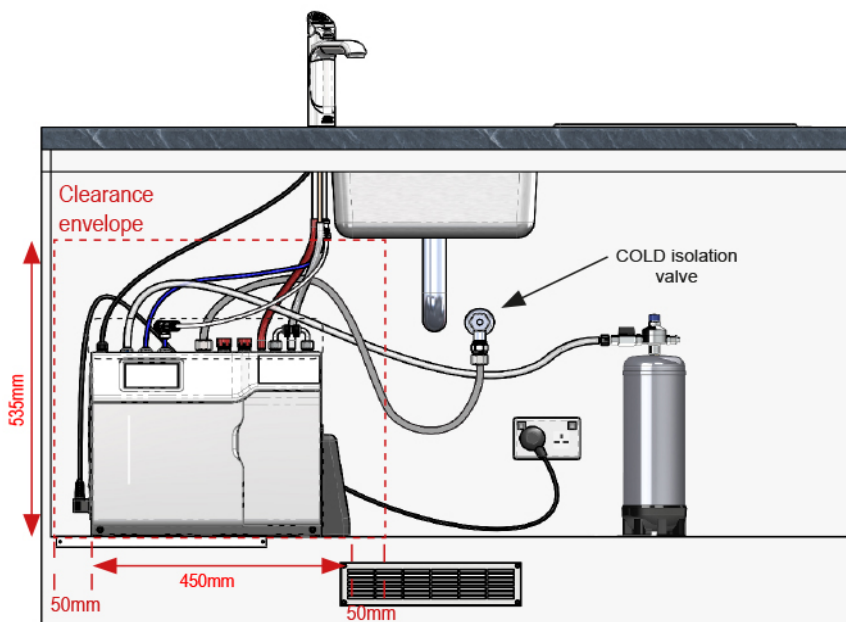





Clearance space required  
for under counter unit



## Accessories

---

Visit [specify.zipwater.co.uk](https://specify.zipwater.co.uk) to find out more information about Zip HydroTap Classic Accessories

Image	SKU	Title
	90915Z1UK	Integrated tap font for HydroTap G4 Classic & Elite brushed chrome
	SP92408	HydroTap Classic 100mm extension piece for G2, G3 & G4 bright chrome
	SP99001	50mm to 35mm hole cut adaptor for HydroTap
	ZT006	Drainless font kit for HydroTap
	ZT013	Font adaptor Billi replacement
	FL250G4KIT	Limescale prevention filter kit 2,250 litres
	FL500G4KIT	Limescale prevention filter kit 3,750 litres
	FL1000G4KIT	Limescale prevention filter kit 7,000 litres
	FL1500G4KIT	Limescale prevention filter kit 10,000 litres

## Accessories

---



FL2000G4KIT Limescale prevention filter kit 16,500 litres

---