

Zip HydroTap Classic



FILTERED: BOILING CHILLED SPARKLING

Offering the choice of instant filtered boiling, chilled or sparkling water, or all three in any combination, the iconic industrial design of the Classic remains a much-loved and popular choice suited to any workplace or home. A safe, energy-efficient and highly functional appliance, we offer models to suit a range of business sizes and needs.



STANDARD



| MODEL | MIXED HOT AND COLD | FILTRATION 0.2 MICRON | FONT | CO ₂ | NOMINAL POWER RATING KW | COMMAND CENTRE DIMENSIONS W X D X H |
|----------|--------------------|-----------------------|------|-----------------|-------------------------|-------------------------------------|
| HT1762UK | N | Y | Y | Y | 2.3 kW @ 230V | 450mm x 470mm x 335mm |

For details of the alternative tap finishes and accessories please see the 'Accessories' section

Features and benefits

Advanced filtration

Integral 0.2 micron NSF certified Zip MicroPurity filtration system offers 25 times better filtration than a standard water filter jug, eliminating bad taste and odour of chlorine, heavy metals and impurities as tiny as one five-thousandth of a millimetre, but leaving beneficial fluoride.

Power-Pulse™ technology

Reduces energy consumption by allowing the system to regulate its power during periods of high and low usage.

Unique safety features

The Zip HydroTap is designed with safety front of mind, with boiling isolation, cool touch tap and safety lock features.

Touchscreen diagnostics

The compact under-counter unit includes a simple PIN code protected touchscreen that puts the user in total control of the system, including temperature, dispensing time, safety features, energy-saving settings and continuous auto-diagnostics.



Product detail

Specification type

| | |
|--------------|--|
| Product code | HT1762UK |
| Product name | HydroTap G4 Classic boiling chilled sparkling 160/175 bright chrome for work |

Capacity, weights & dimensions

| | |
|-------------------------------|-----------------------------|
| Water functions | Boiling, Chilled, Sparkling |
| Boiling capacity | 160 Cups per hour |
| Chilled capacity | 175 Glasses per hour |
| Sparkling capacity | 175 Glasses per hour |
| Unit dimension (W x D x H) | 450mm x 470mm x 335mm |
| Product weight - empty / full | 39kg / 47kg |

Plumbing

| | |
|---------------------------------------|--|
| Wholesome water inlet supply required | Cold Feed |
| Supply pressure range | 2.5bar - 5bar |
| Supply connection (hot & cold) | 1 x isolated 1/2" bsp BSP fitting (flexible supply hoses included) |
| Installation | Must comply with current water supply regulations |

Electrical

| | |
|-----------------------------|--|
| Command centre power rating | 2.3 kW @ 230V |
| Voltage supply | 13 amps |
| Power supply requirements | 1 x 13amp socket outlet |
| Cable length | 1.8m fitted with UK standard 3-pin plug |
| Installation | Must comply with current IEE regulations |

Tap design

| | |
|----------------------------|------------------|
| Style | HydroTap Classic |
| Finish | Bright Chrome |
| Installation hole cut size | 35mm |
| Rotation | Fixed |
| Disability options | Yes |
| Country of Origin | Australia |

Command centre

| | |
|-------------------------------------|-----------------------------|
| Factory temperature boiling | 98°C |
| Factory temperature chilled | 3-5°C |
| Filtration | 0.2 Micron Filter Cartridge |
| Flow rate | 3.0-4.0 l/min |
| Wholesome water supply requirements | Cold Feed |
| Refrigerant | R134a |
| Tank material | Stainless Steel |
| Country of origin | Australia |

Tap installation

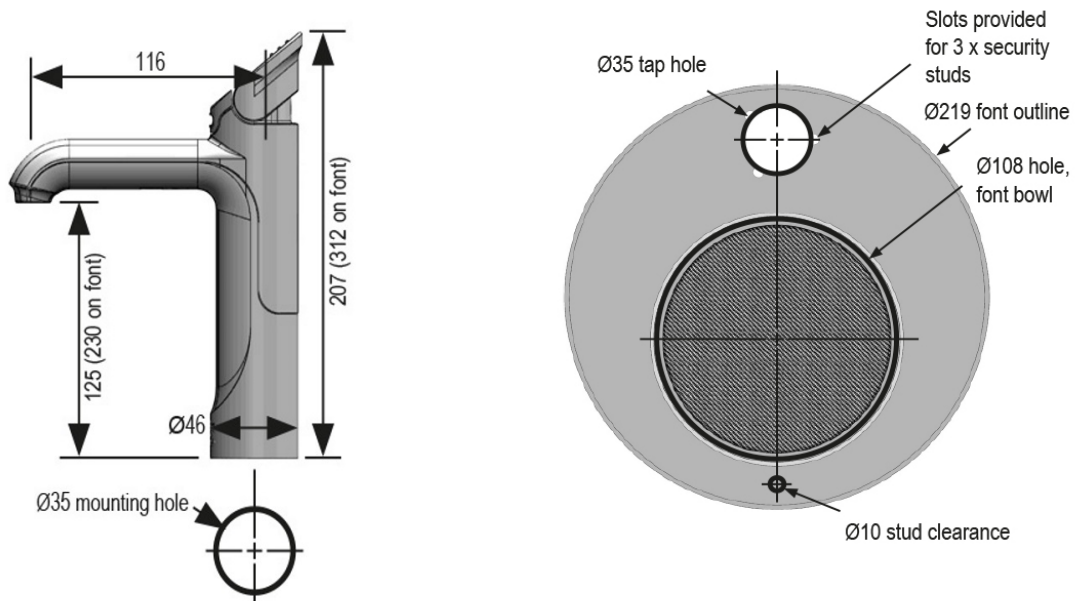





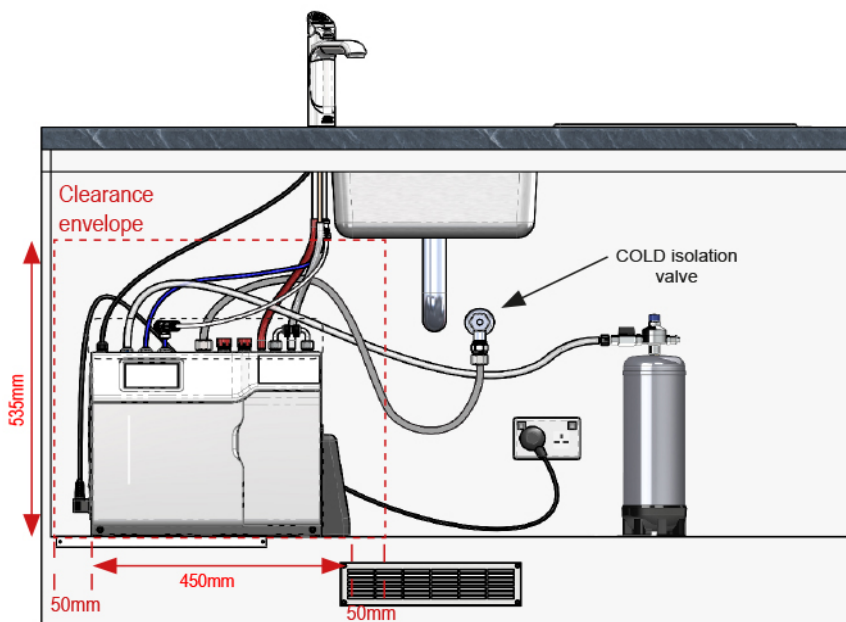



Under-counter unit installation

Clearance space required
for under counter unit



Accessories

Visit specify.zipwater.co.uk to find out more information about Zip HydroTap Classic Accessories

| Image | SKU | Title |
|---|-------------|--|
|  | 90915UK | Integrated tap font for HydroTap G4 Classic & Elite bright chrome |
|  | SP92408 | HydroTap Classic 100mm extension piece for G2, G3 & G4 bright chrome |
|  | SP99001 | 50mm to 35mm hole cut adaptor for HydroTap |
|  | ZT006 | Drainless font kit for HydroTap |
|  | ZT013 | Font adaptor Billi replacement |
|  | FL250G4KIT | Limescale prevention filter kit 2,250 litres |
|  | FL500G4KIT | Limescale prevention filter kit 3,750 litres |
|  | FL1000G4KIT | Limescale prevention filter kit 7,000 litres |
|  | FL1500G4KIT | Limescale prevention filter kit 10,000 litres |

Accessories



FL2000G4KIT Limescale prevention filter kit 16,500 litres
